

MARKEM®

Smart Traverse

Operating Manual

Revised: 4:13:04

SMARTMOVE
PRODUCT SPECIFICATIONS

PRINT AREA	TRAVERSE ACTUATOR LENGTH MINUS 11 INCHES
SUBSTRATE AREA	TRAVERSE ACTUATOR LENGTH MINUS 5 INCHES
TRAVERSE SPEED	12 - 20 Cycles per Minute
POWER SUPPLY	115 /230 VAC, 8 A MAX
ENVIRONMENTAL	32 DEG F TO 95 DEG F
TRAVERSE DIMENSIONS	13.5"H x 14.5"W x "A" DIMENSION W
CONTROLLER DIMENSIONS	12"W x 14"H x 8"D
TRAVERSE WEIGHT	62.4 Lbs @ 26.5" A Dimension
CONTROLLER WEIGHT	32.2 Lbs
MACHINE INTERFACE	INPUTS: CYCLE INPUT; OUTPUTS; INTERLOCK OUTPUT
OPERATOR INTERFACE	STN; 320 x 240 LCD WITH BACKLIGHT 4.6"W x 3.5"H (117 x 88mm)

OPTIONS	ETHERNET NETWORK OPTION
---------	-------------------------

POWER-UP

1. PRESS THE HOME BUTTON

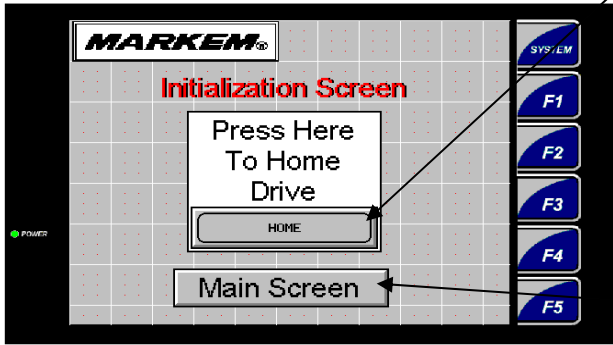

THE PRINTER WILL COMMENCE A HOMING MOVE.

ONCE THE PRINTER HAS FINISHED THE HOME MOVEMENT.....

2. PRESS THE MAIN SCREEN BUTTON

SELECT FORMAT

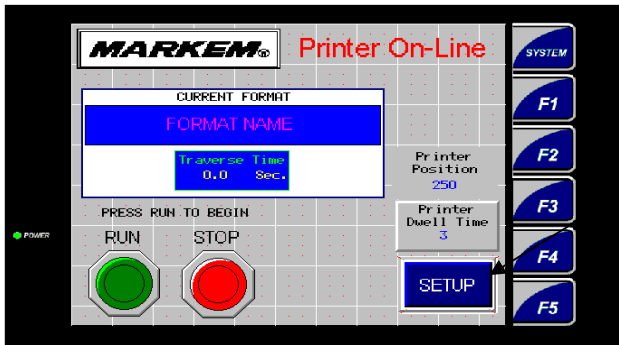

1. PRESS THE SETUP BUTTON

THE SCREEN WILL CHANGE TO THE SETUP SCREEN.

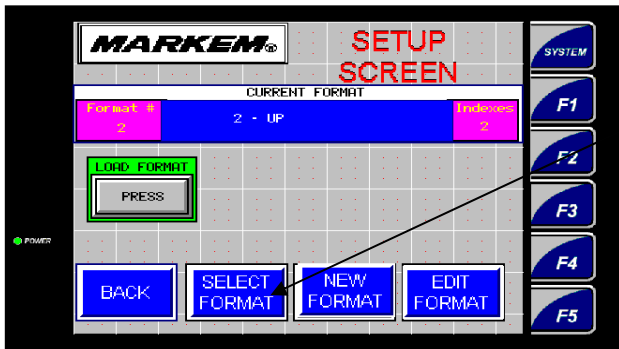

2. PRESS THE SELECT BUTTON

THE SCREEN WILL CHANGE TO THE SELECT FORMAT SCREEN.

NOTE: DEPENDING ON PASSWORD CONFIGURATION, THE SELECT BUTTON MAY NOT BE ACCESSIBLE.

SEE SECTION XX FOR PASSWORD

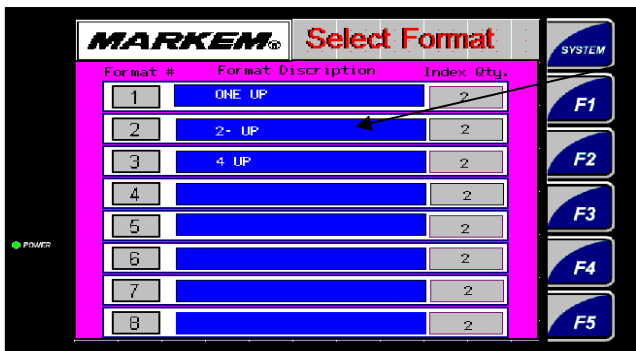

3. SELECT THE FORMAT BY PRESSING THE FORMAT NAME

THE SCREEN WILL CHANGE BACK TO THE SETUP SCREEN.

CONTINUED →

CREATING A NEW FORMAT

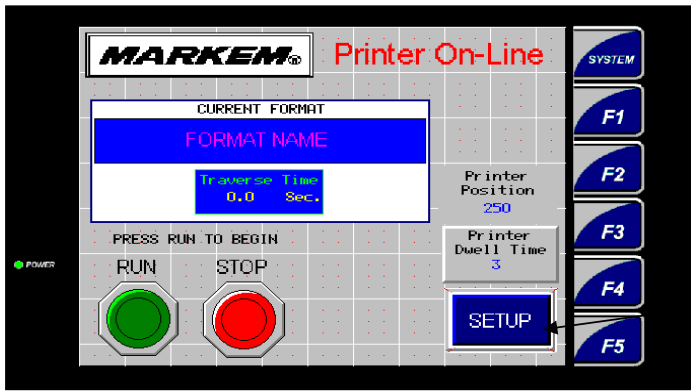

THE PRINTER MUST BE IN THE STOPPED POSITION TO GO TO THE SETUP SCREEN.

1. PRESS THE SETUP BUTTON

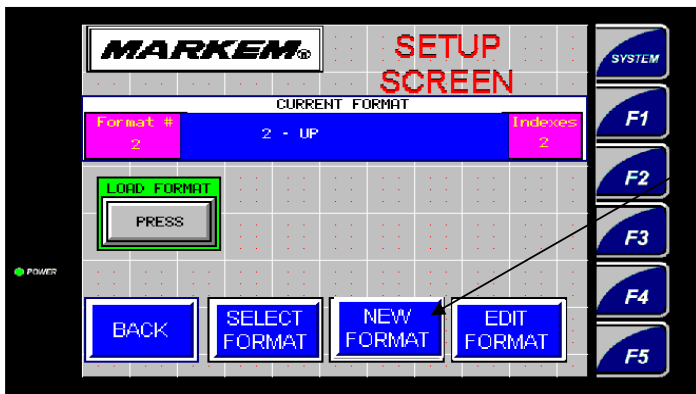

2. PRESS THE NEW FORMAT BUTTON

NOTE: DEPENDING ON PASSWORD CONFIGURATION, THE SELECT BUTTON MAY NOT BE ACCESSIBLE.

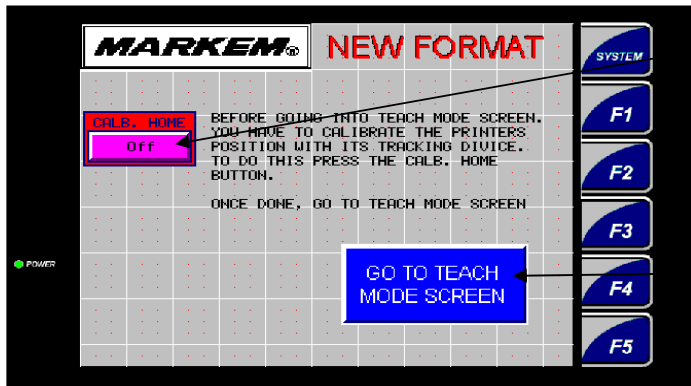

3. PRESS THE CALIBRATE HOME BUTTON

THE PRINTER WILL COMMENCE A HOME MOVE.

4. PRESS THE "TEACH MODE" BUTTON.

IMPORTANT: FOLLOW THE NEXT STEPS IN THE FOLLOWING ORDER.

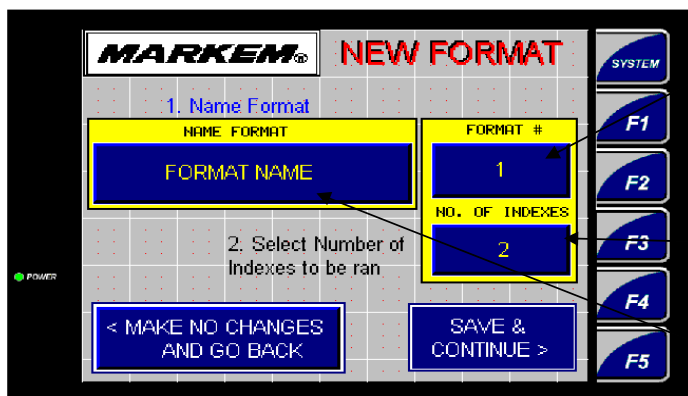

5. PRESS THE "FORMAT #"

WARNING: CHOOSING AN EXISTING FORMAT WILL OVERWRITE THE EXISTING DATA.

6. SELECT THE NUMBER OF INDEXES

7. SELECT THE FORMAT NAME

CONTINUED →

CONTINUED

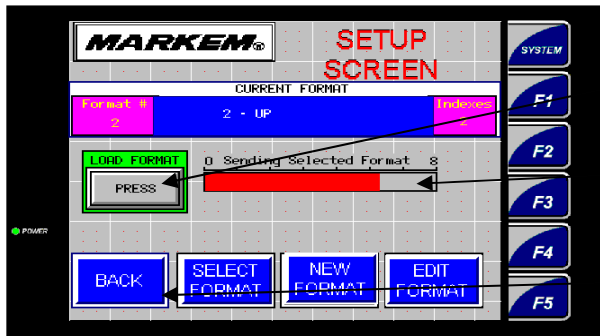

4. PRESS THE "LOAD FORMAT"

THE LOADING BAR WILL BEGIN LOADING THE FORMAT.

5. UPON COMPLETION OF THE LOADING BAR, PRESS THE "BACK" BUTTON

STARTING THE PRINTER

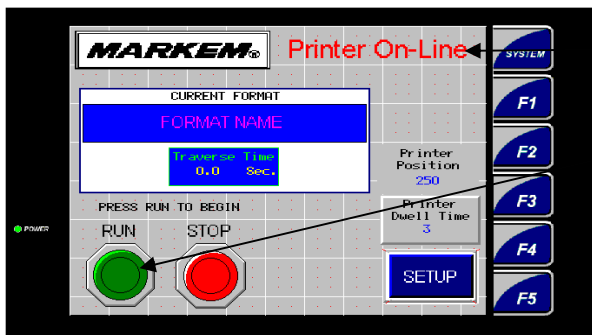

THE PRINTER MUST BE "ON-LINE" BEFORE THE PRINTER WILL CYCLE.

6. PRESS THE "RUN" BUTTON TO BEGIN.

NOTE: THE PRINTER WILL MOVE TO THE FIRST POSITION ONCE THE "START" BUTTON IS PRESSED.

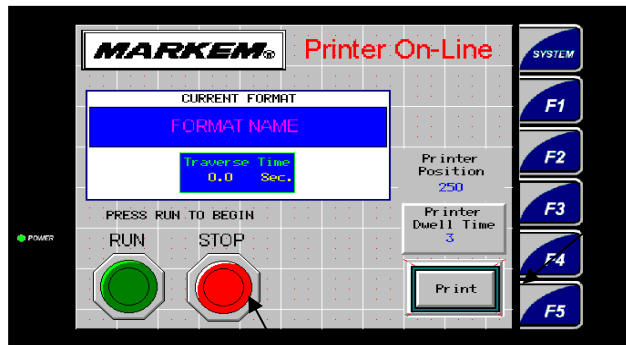

7. PRESS THE "PRINT" BUTTON TO RUN A TEST PRINT.

NOTE: THE TEST PRINT BUTTON MAY NOT BE VISIBLE DEPENDING ON PASSWORD CONFIGURATION.

STOPPING THE PRINTER

8. PRESS THE "STOP" BUTTON TO STOP THE PRINTER FROM CYCLING.

→ **CONTINUED**
NAMING THE FORMAT

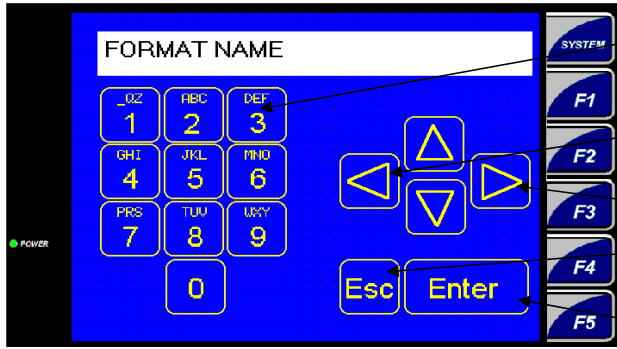

1. PRESS THE NUMERIC KEY UNTIL THE DESIRED LETTER OR NUMBER IS DISPLAYED.

2. PRESS THE APPROPRIATE ARROW KEYS TO SHIFT LEFT OR RIGHT.

3. PRESS THE "ENTER" BUTTON TO SAVE THE ENTERED NAME OR "ESC" TO EXIT WITHOUT SAVING.

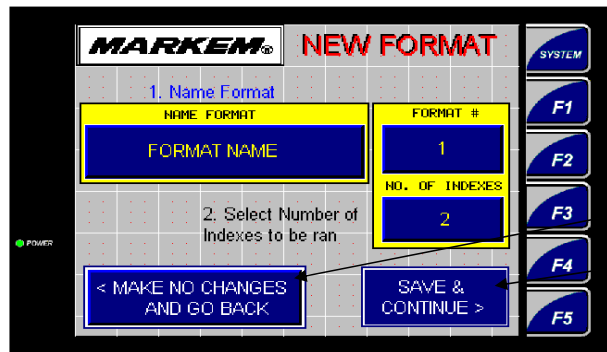

ONCE ALL THE INFORMATION IS CORRECT

4. PRESS THE "SAVE" BUTTON TO CONTINUE OR THE "BACK" BUTTON TO EXIT WITHOUT SAVING DATA.

TEACHING THE POSITIONS

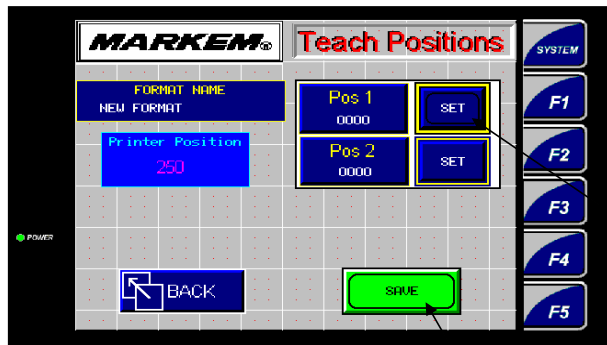

2 WAYS TO SET THE PRINT POSITIONS

MANUALLY MOVE THE PRINTER TO THE FIRST PRINT POSITION.

NOTE: THE MOTOR SIDE OF THE MACHINE MUST BE POSITION 1.

1. ONCE THE PRINTER IS IN THE DESIRED PRINT POSITION, PRESS THE "SET" BUTTON ASSOCIATED WITH THE APPROPRIATE POSITION.

REPEAT THIS STEP FOR EACH PRINT INDEX.

3. PRESS THE "BACK" BUTTON TO EXIT

2. PRESS THE SAVE BUTTON TO STORE THE POSITIONS.

OR

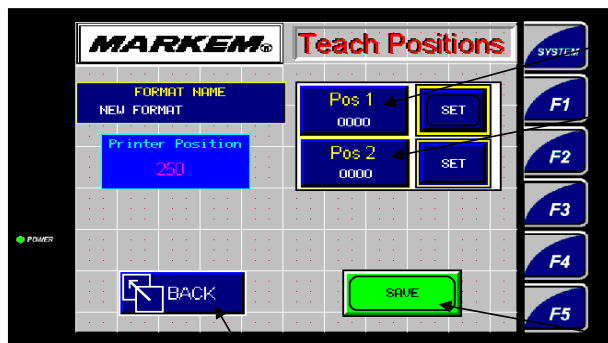

1. ENTER THE NUMERIC VALUES FOR EACH INDEX BY PRESSING THE POSITION BUTTONS AND KEY THE NUMERIC VALUE FOR EACH POSITION.

REPEAT THIS STEP FOR EACH PRINT INDEX.

NOTE: MINIMUM AND MAXIMUM VALUES FOR RANGE FROM 0 TO 3800.

2. PRESS THE SAVE BUTTON TO STORE THE POSITIONS.

3. PRESS THE "BACK" BUTTON TO EXIT

SPEED SETTINGS

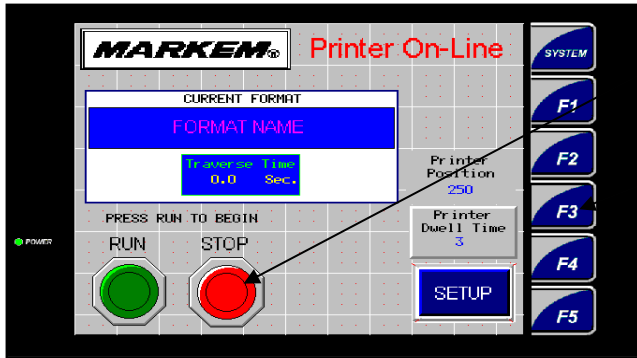

STOP THE TRAVERSING SYSTEM BY PRESSING THE "STOP" BUTTON.

1. PRESS THE "F3" KEY.

NOTE: YOU WILL NEED TO HAVE A LEVEL 3 OR HIGHER PASSWORD CLEARANCE TO ACCESS THIS PARAMETER CHANGE.

PASSWORD PROMPT

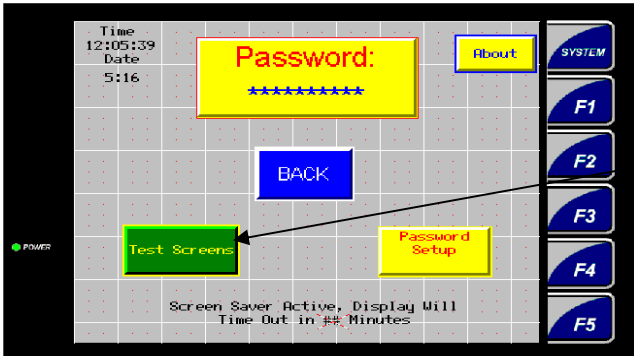

DEPENDING ON PASSWORD LEVEL. NOT ALL KEYS MAY BE VISABLE

1. PRESS THE "TEST SCREENS" BUTTON

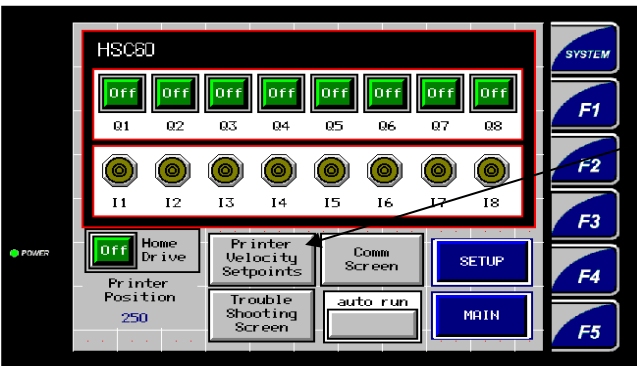

2. PRESS THE "PRINTER VELOCITY SETPOINTS" BUTTON.

THE SCREEN WILL CHANGE TO THE VELOCITY SETTINGS SCREEN.

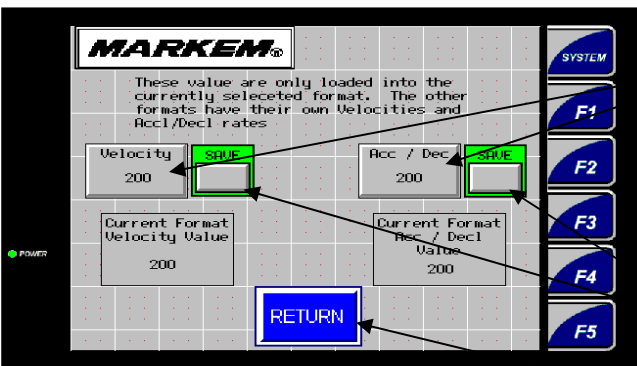

3. SELECT THE VELOCITY OR ACC/DEC BUTTONS TO CHANGE SPEED SETTINGS.

3. PRESS THE "SAVE" BUTTON TO SAVE CHANGES.

IMPORTANT: YOU MUST SAVE CHANGES OR ADJUSTMENTS WILL NOT TAKE EFFECT.

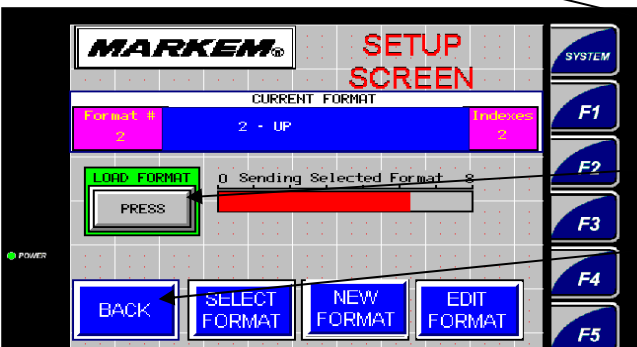

4. PRESS "RETURN" TO EXIT SCREEN.

IMPORTANT: YOU MUST RELOAD FORMAT FOR CHANGES TO TAKE EFFECT.

5. LOAD FORMAT.

6. PRESS THE "BACK" BUTTON TO RETURN TO THE MAIN SCREEN.

SPEED SETTINGS HAVE

TRAVERSING VELOCITY / ACCEL / DECEL SETTINGS.

The SmartMove 1 Plus traversing system speed settings are fully adjustable. Access to these parameters are password protected and restricted access to these settings is extremely important. Changing the settings requires a password of level 4 or higher.

Recommended Settings: *Most applications can be accomplished using these settings.*

Velocity: 125

Accel/Decel: 125

Speed settings related to periodic maintenance:

Settings higher than:

Velocity: 250

Accel/Decel: 250

will require daily maintenance requiring adjustment to belt tension bearing fit up and the possible addition of an enclosure cooler to operate in ambient temperatures above 80 deg F.

Speed setting related to shorter life of wear components:

Settings higher than:

Velocity: 250

Accel/Decel: 250

will shorten the expected life of the drive components. (ie: bearings, V rails, gear motor, etc).

A good rule of thumb: Run the system as slow as possible to complete the cycle within the allowable dwell time.

Important: Changes made to Velocity and Accel / Decel settings are associated with the current selected format. Each format contains speed parameters reducing the need to change these settings.

Viewing the speed settings can be accessed through the Edit Format procedure.

Lubrication

Lubrication is the key to maximizing the life of a V-Bearing linear guide. Internally, V-Bearing guide wheels are lubricated for life with an extreme pressure, corrosion resistant grease. However, lubrication of the wheel/track interface is the responsibility of the user. A light machine oil or an extreme pressure grease will serve well in minimizing wear, stick slip, and corrosion on the guide ways in a V-Bearing-based design.

Lubrication will maximize the load capacity of an individual bearing element. As such, for any specific application loading condition, the presence of lubrication on the guide ways will significantly increase the service life over a non-lubricated configuration under the same loads.

Lubrication will also increase the maximum linear velocity that a V-Bearing bearing arrangement can endure. In applications where high speed or high acceleration rates are present, lubrication of the wheel/track interface is highly recommended.

Lastly, lubrication will reduce the overall coefficient of friction of the guide, which, depending on the level of preload, can fall anywhere from 0.008 to 0.15. Replenishment or replacement of the lubrication wiper assembly should take place on a monthly basis or more often as necessary depending on environment.

Fit-Up

Normal adjustment is obtained by rotating the eccentric bushings until all free play is removed from the carriage assembly. When the eccentrics are adjusted and the carriage plate is held firmly in place, one should be able to rotate, by hand, any of the four guide wheels in the system against its mating track. If rotation is not possible, preload on the wheels should be reduced accordingly.

Overtightening of the eccentric adjustment could result in premature bearing failure. Such a condition can exert a force greater than the load rating of the wheel. The fit-up procedure should be checked on a weekly basis to insure proper fit and extended bearing life.

TRAVERSING SYSTEM TROUBLE SHOOTING GUIDE

TROUBLE	POSSIBLE CAUSE	RECOMMENDED ACTION
POWER	MAIN POWER CHECK DRIVE POWER	VALIDATE INCOMING POWER RESET BREAKER LOOSE WIRE CONNECTION
DRIVE STATUS	DRIVE ERRORS TRAVEL LIMITS EXCEEDED	CYCLE POWER ON DRIVE CHECK SERVO MOTOR CONNECTIONS CHECK LIMIT SWITCH ADJUSTMENT ADJUST POSITION SETTINGS TO STAY WITHIN LIMITS
FORMAT PARAMETERS	VELOCITY SETTING POSITION SETTINGS	CHANGE VELOCITY SETTINGS CHANGE POSITION SETTINGS
CABLE CONNECTION		PLACE IN LASER MODE PLACE IN AUTO RUN MODE EXTEND SERVICE LOOP IN TRAVERSING CABLES
PLC STATUS	PLC NOT IN RUN MODE	PLACE PLC IN RUN MODE
HOMING ERROR	MAGNET MISSING DAMAGE TO SENSOR CHECK WIRING / SOLDER CONNECTIONS	REPLACE MAGNET REPLACE SENSOR CHECK WIRING / SOLDER CONNECTIONS
COMMUNICATION ERROR	CABLE DAMAGED EXCESS NOISE OR FLOATING GROUND	REPLACE COMM CABLE CHECK EARTH GROUND

SmartMove 1+ IO Screen

OUTPUTS

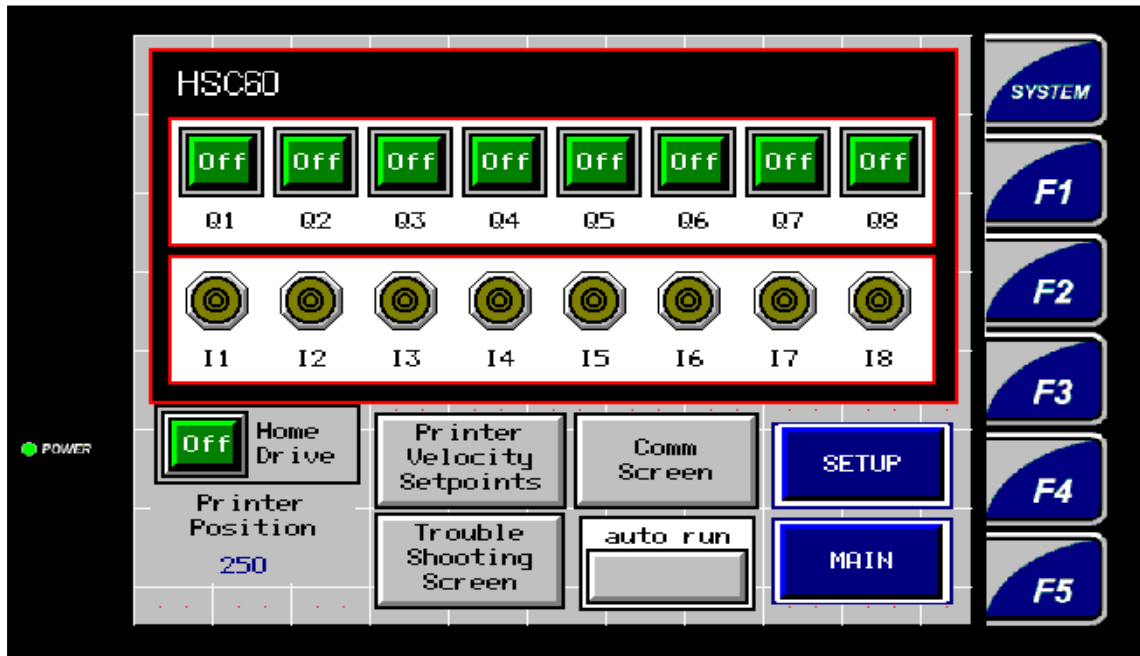

INPUTS

OUTPUT ASSOCIATION

Q1	PRINT COMMAND
Q2	INDEX DRIVE ZERO
Q3	INDEX DRIVE ONE
Q4	INDEX INITIATE
Q5	POWER INDEXER
Q6	POWER INDEXER
Q7	HOME COMMAND
Q8	ENABLE DRIVE

INPUT ASSOCIATION

I1	CHANNEL A
I2	CHANNEL B
I3	PRINTER BUSY
I4	INDEX COMPLETE
I5	HOME COMPLETE
I6	MACHINE INPUT
I7	PRINTER READY
I8	DRIVE FAULT

PASSWORD SETTINGS

- Open
 - Start Stop System
- Level 1
 - Select Formats
 - Start Stop System
- Level 2
 - Select Formats
 - Start Stop System
 - Edit Print Positions
- Level 3
 - Select Formats
 - Start Stop System
 - Edit Print Positions
 - Creat New Positions
- Level 4
 - Select Formats
 - Start Stop System
 - Edit Print Positions
 - Creat New Positions
 - Edit Speed Settings
 - Edit Debounce Setting
- Master
 - Select Formats
 - Start Stop System
 - Edit Print Positions
 - Creat New Positions
 - Edit Speed Settings
 - Edit Debounce Setting
 - Password Setup
 - System Setup

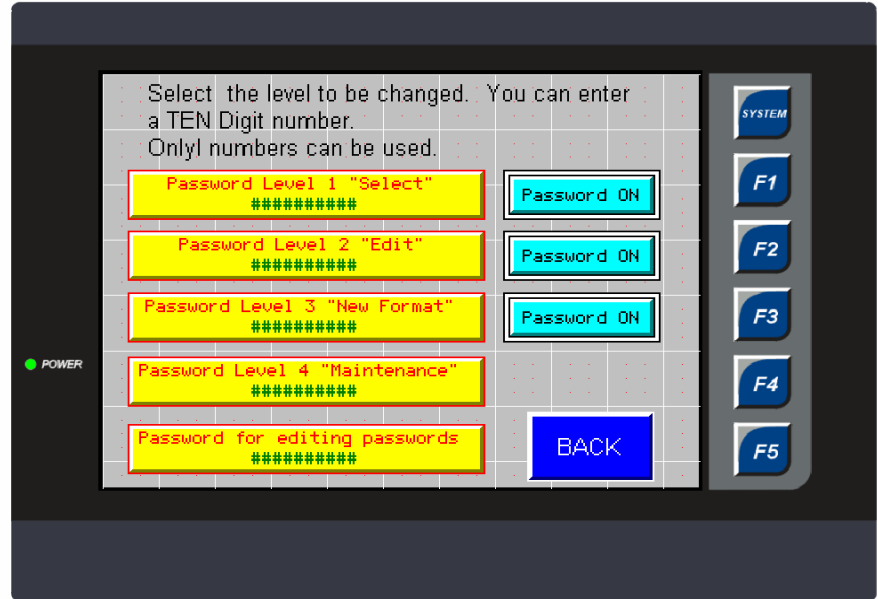

OUTPUT CONFIGURATION SCREEN

Only 1 Function for each output can be active and any given time.

State of Output can be changed from "Normally Open" to "Normally Closed"

The screen displays the following function definitions:

- F1= End of Printing Pulse
- F2= Printer System Online
- F3= Alarm Output
- F4= Print Command
- F5= Dual Printer with Index Skip

Output	F1	F2	F3	F4	F5
SSR7 FUNCTION SETUP	Red	Green	Red		
SSR8 FUNCTION SETUP				Green	
SSR9 FUNCTION SETUP	Red	Red	Green		
SSR10 FUNCTION SETUP	Red	Red	Red		Green

On the left side of the screen, there is a 'POWER' indicator (a green dot) and a 'NO' button next to each function setup row. On the right side, there is a vertical column of buttons labeled 'SYSTEM', 'F1', 'F2', 'F3', 'F4', and 'F5'.

PASSWORD SETTINGS

- Open
 - Start Stop System
- Level 1
 - Select Formats
 - Start Stop System
- Level 2
 - Select Formats
 - Start Stop System
 - Edit Print Positions
- Level 3
 - Select Formats
 - Start Stop System
 - Edit Print Positions
 - Creat New Positions
- Level 4
 - Select Formats
 - Start Stop System
 - Edit Print Positions
 - Creat New Positions
 - Edit Speed Settings
 - Edit Debounce Setting
- Master
 - Select Formats
 - Start Stop System
 - Edit Print Positions
 - Creat New Positions
 - Edit Speed Settings
 - Edit Debounce Setting
 - Password Setup
 - System Setup

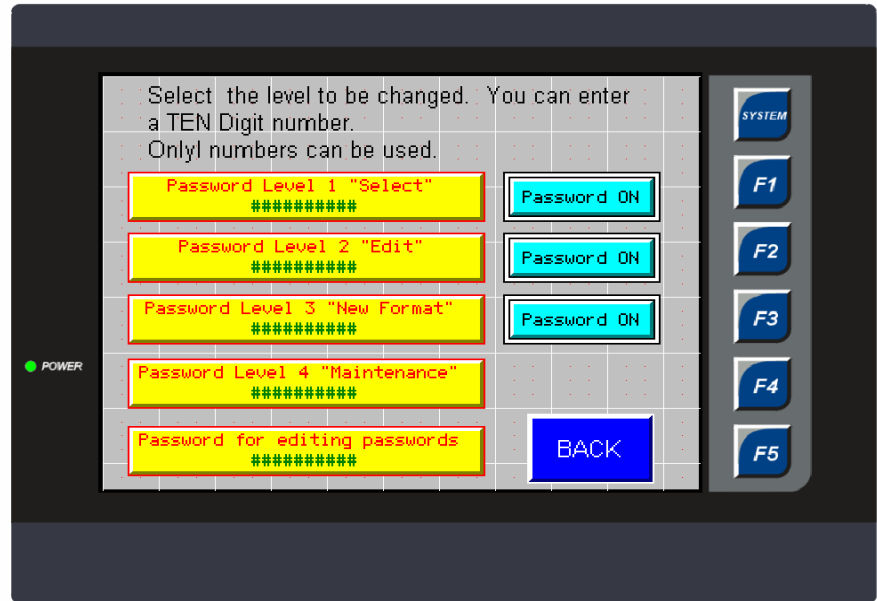







Diagnosics and Troubleshooting



Diagnostic Display

The diagnostic display on the front of the drive shows drive and FM-2 Module status and fault codes. When a fault condition occurs, the drive will display the fault code, overriding the status code.

The decimal point is “On” when the drive is enabled and the stop input is not active. This indicates that the drive is ready to run and any motion command will cause motion. Motion commands will not cause motion unless you are Ready (R) and the decimal point is “On”.

Display Indication	Status	Description
	Brake Engaged (Output "Off")	Motor brake is mechanically engaged. This character will only appear if the Brake output function is assigned to an output line.
	Disabled	Power Stage is disabled.
	Ready	The Epsilon Ei or FM-2 and E Series drive system is functioning normally and is ready to execute a motion command.
	Indexing	Index in progress. Other motion commands do not function.
	Jogging	Jog function in progress. Other motion commands do not function.
	Homing	Home cycle in progress. Other motion commands do not function.
	Stop or Travel Limit Decel	<i>Stop or Travel Limit Decel</i> in progress.

Epsilon Ei Indexing Drive Installation Manual



Display Indication	Status	Description
	RMS Foldback	Motor torque is limited to 80 percent.
	Stall Foldback (E Series drive only)	Drive output current is limited to 80 percent of drive stall current.
	Ready to Run	Drive enabled, no <i>Stop</i> input.

Fault Codes

A number of diagnostic and fault detection circuits are incorporated to protect the drive. Some faults, like high DC bus and amplifier or motor over temperature, can be reset with the Reset button on the front of the drive or the Reset input function. Other faults, such as encoder faults, can only be reset by cycling power "Off" (wait until the diagnostics display turns "Off"), then power "On".

The drive accurately tracks motor position during fault conditions. For example, if there is a "Low DC Bus" fault where the power stage is disabled, the drive will continue to track the motor's position provided the logic power is not interrupted.

The +/- Limit faults are automatically cleared when the fault condition is removed. The table below lists all the fault codes in priority order from highest to lowest. This means that if two faults are active, only the higher priority fault will be displayed.

Display	Fault	Action to Reset	Bridge Disabled
	Flash Invalid	Reprogram the FM's Flash	Yes
	Drive Overtemp (Epsilon drive only)	Cool down, Cycle Power	Yes
	Power Up Test	Power	Yes

Diagnostics and Troubleshooting

Display	Fault	Action to Reset	Bridge Disabled
N	NVM Invalid	Button or Input	Yes
U	Invalid Configuration	Button or Input	Yes
Z	Power Module	Button or Input	Yes
H	High DC Bus	Button or Input	Yes
L	Low DC Bus	Button or Input	Yes
P	Encoder State	Power	Yes
E	Encoder Hardware	Power	Yes
M	Motor Overtemp	Button or Input	Yes
S	RMS Shunt Power	Button or Input	Yes
O	Overspeed	Button or Input	Yes

Epsilon Ei Indexing Drive Installation Manual

Display	Fault	Action to Reset	Bridge Disabled
F	Max Following Error (Position mode)	Button or Input	Yes
L	Travel Limit +/-	Auto	No
	All "On"	Normally on for one second during power up	Yes

Fault Descriptions

Flash Invalid

This fault indicates that the firmware checksum has failed. Use the Tools|Program Flash menu item from PowerTools FM to reprogram/upgrade the firmware stored in flash memory. If this problem persists, call Control Techniques. A common cause would be an interrupted F/W Flash upgrade (cable disconnected in the middle of an upgrade process).

Drive Overtemp

Indicates the drive IGBT temperature has reached 100°C (212°F).

Power Up Test

This fault indicates that the power-up self-test has failed. This fault cannot be reset with the reset command or reset button.

NVM Invalid

At power-up the drive tests the integrity of the non-volatile memory. This fault is generated if the contents of the non-volatile memory are invalid.

Invalid Configuration



Epsilon Only

If this occurs call Technical Support at Control Techniques.

▲ CAUTION

Damage may occur to the drive, motor or both if the fault is cleared using the Reset button when the setup data in the FM does not match the current drive and motor.

Z Power Module

This fault is generated when a power stage over-temperature, over-current or loss of power stage logic supply occurs. This can be the result of a motor short to ground, a short in the motor windings, a motor cable short or the failure of a switching transistor.

It can also occur if the drive enable input is cycled "Off" and "On" rapidly (>10 Hz).

H High DC Bus

This fault will occur whenever the voltage on the DC bus exceeds 440 VDC. The most likely cause of this fault would be an open shunt fuse, a high AC line condition or an application that requires an external shunt (e.g., a large load with rapid deceleration).

Ⓛ Low DC Bus

This fault will occur whenever the voltage on the DC bus drops below 60 volts. The most likely cause of this fault is a reduction (or loss) of AC power. A 50 ms debounce time is used with this fault to avoid faults caused by intermittent power disruption. For some types of custom motors it may be necessary to disable this fault. Refer to the Advanced Tab section of Setting Up Parameters for more information.

ⓔ Encoder State

Certain encoder states and state transitions are invalid and will cause the drive to report an encoder state fault. This is usually the result of noisy encoder feedback caused by poor shielding.

E Encoder Hardware

If any pair of encoder lines are in the same state, an encoder line fault is generated. The most likely cause is a missing or bad encoder connection.

Ⓜ Motor Overtemp

This fault is generated when the motor thermal switch is open due to motor over-temperature or incorrect wiring.

Epsilon Ei Indexing Drive Installation Manual

□	Overspeed
---	------------------

This fault occurs when the actual motor speed exceeds the Overspeed Velocity Limit parameter. This parameter can be accessed with PowerTools-FM software.

⌈	Max Following Error
---	----------------------------

This fault is generated when the following error exceeds the following error limit (default following error limit is 0.2 revs). With PowerTools-FM you can change the Following Error Limit value or disable it on the Position tab.

⌋	Travel Limit +/-
---	-------------------------

This fault is caused when either the + or - Travel Limit input function is active.

■	All "On"
---	-----------------

This is a normal condition during power up of the drive. It will last for less than 1 second. If this display persists, call Technical Support at Control Techniques.

ACTUATOR DETAIL

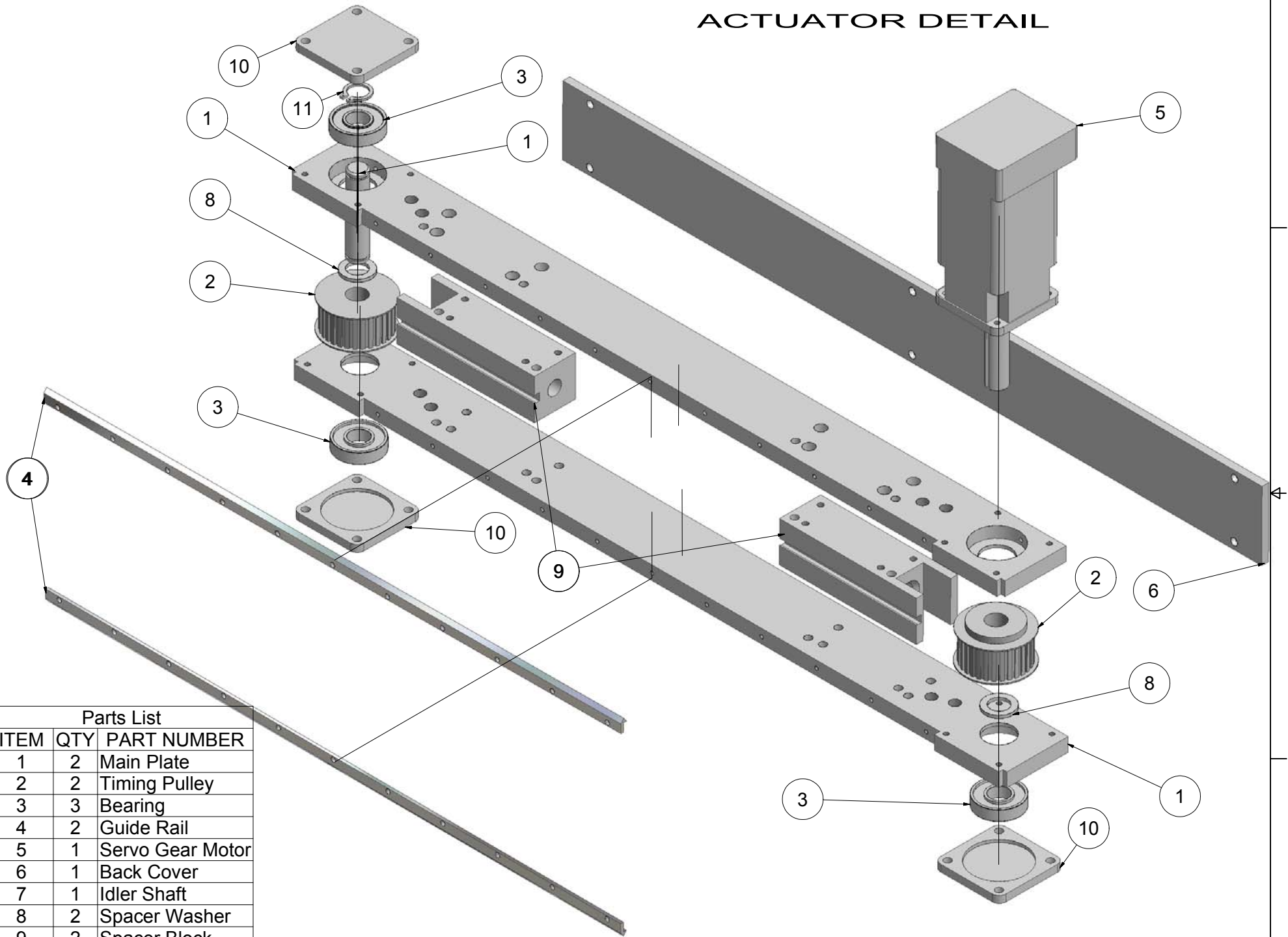

Parts List

ITEM	QTY	PART NUMBER
1	2	Main Plate
2	2	Timing Pulley
3	3	Bearing
4	2	Guide Rail
5	1	Servo Gear Motor
6	1	Back Cover
7	1	Idler Shaft
8	2	Spacer Washer
9	2	Spacer Block
10	3	Bearing Cover
11	2	Snap Ring

Carriage Assembly

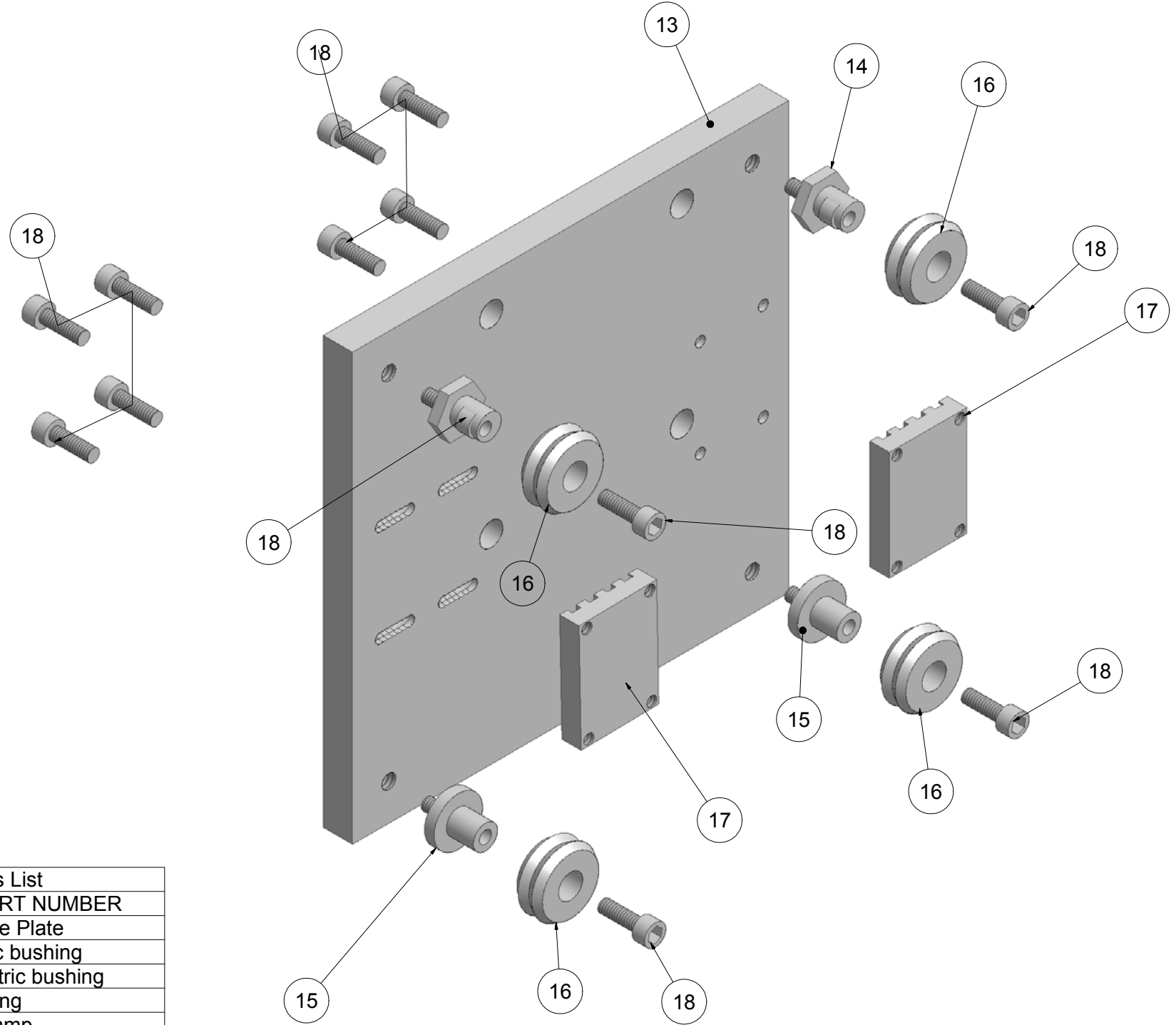

Parts List		
ITE	QT	PART NUMBER
13	1	Carriage Plate
14	2	eccentric bushing
15	2	concentric bushing
16	4	V Bearing
17	2	Belt Clamp
18	16	Cap Screw

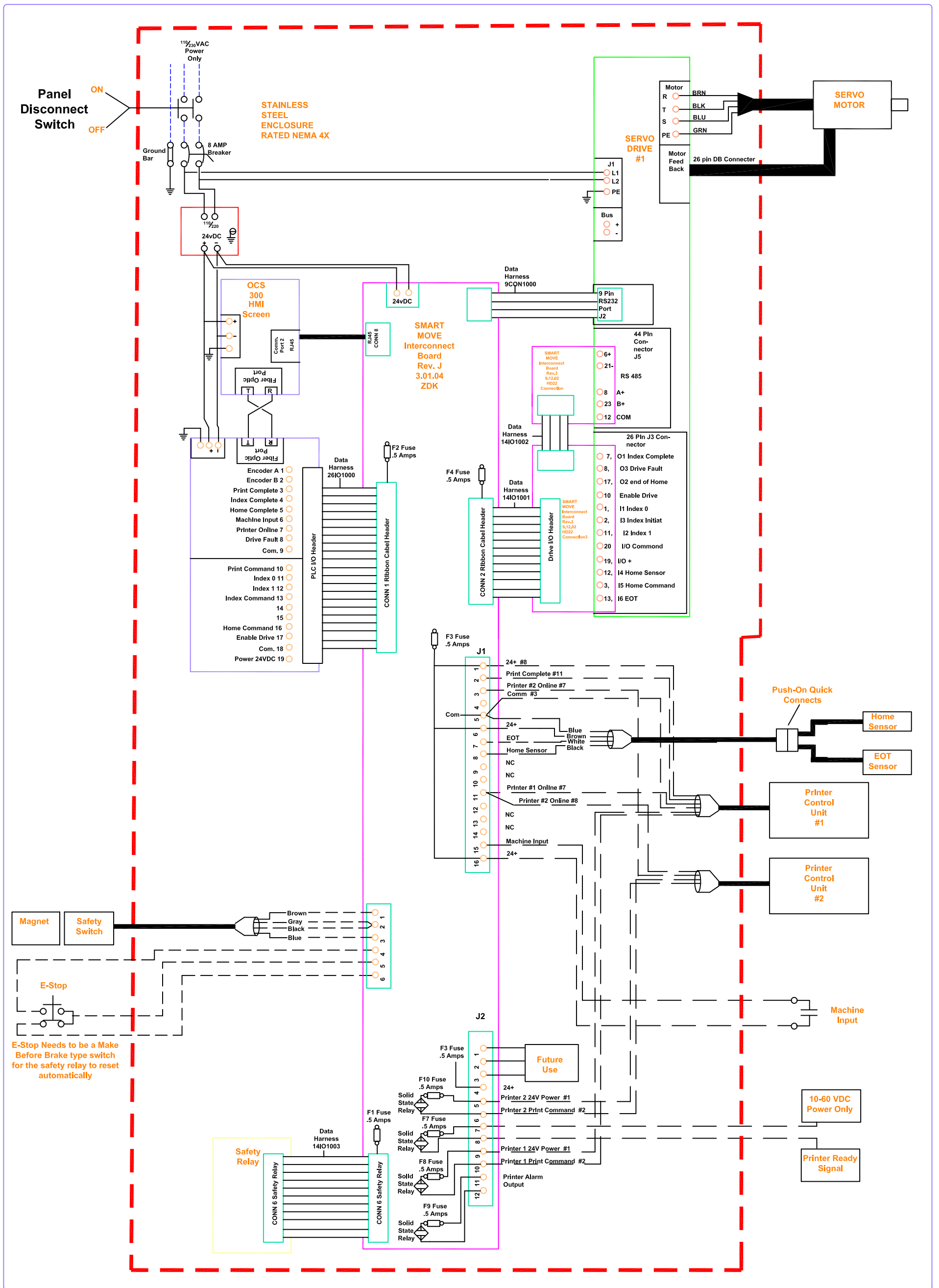

SMART MOVE
 MOTION CONTROL ENGINEERING
 1501 WEST 10 St
 SIOUX FALLS, SD 57104
 TEL. (605) 336-6624

This drawing is the confidential property of SMART MOVE, and must be returned, without reproduction or duplication, at any time, upon request. But, in any event, at completion of the work or job, while in possession of the recipient, it must be properly safeguarded against revelation or disclosure to anyone except those employees who require it for the work or job. The recipient must keep confidential and require his (its) employees to keep confidential the information contained herein.

Project & Sheet Title
SCHEMATIC WIRING
DIAGRAM FOR
SMART MOVE PLUS

Project Number:
 TX2L-S1D2R31-UNI-SPCL
 1-017-03
Date:
 ZDK
Drawn By:
 DS
Checked By:
 01-15-03T Copyright SMART MOVE

Ref. Plan: REFPLAN
Ref. P&ID: REFP&ID
120EI203-072502-XXXXX

MKM P/N	Qty	Description
0672635	1	Color Controller
0672633	1	FOX I/O Base
0672634	1	High Speed Counter
0672637	1	Digital IO
0251130	1	Servo Motor 5:1
0251131	1	Servo Motor 10:1
0672638	1	Indexing Drive 2 amp
0672646	1	Indexing Drive 3 amp
0688523	1	Cable Motor
0688524	1	Cable Encoder
0688525	1	Cable Comnd
0672639	1	Breakout Board
0672640	1	Circuit Board Main
0672641	1	Circuit Board Lite
0672642	1	1.3A DC Power Supply
0672647	1	0.3A DC Power Supply
0688536	1	DIN Rail
0688526	1	Ribbon Cable
0688527	1	Fuse Circuit Brd
0688528	1	2 Pole, 8A Circuit Bkr
0242235	1	E-Stop w/ 1NC Contact
0242236	1	Disconnect Kit
0672643	1	Circuit Board Drv
0672644	1	Circuit Board Enc
0672645	1	Circuit Board EIO
0211358	3	Bearings
0221301	2	Timing Pulley
0630899	1	Timing Belt
0947799	1	Idler Shaft
0960831	2	36.5" SS Single Edge Track
0960832	2	24.5" SS Single Edge Track
0211359	2	ECC Bearing SS
0211360	2	Con Bearing SS
0211362	4	Size 1 SS Guide Wheel
0960833	1	35" Utilitrak Rail
1283831	1	SS Utilitrak Carriage
1531979	1	Size 1 Adjuster Wrench
1283805	1	Carriage Plate Std
1283806	1	Carriage Plate Extd
1010153	1	Magnet
1283807	2	Timing Belt Clamp
1283808	1	Actuator Back Cover
1283809	2	Cable Clamps
1283810	1	Linear Stabilizer
1283811	1	Stabilizer Sup Bracket
1283812	1	Print Platen
0422382	1	Print Platen Pad
2170549	1	VB Connector
0242234	1	Limit Switch
0688537	1	Bulkhead Receptacle
0688538	1	MultiPort Blkhd Passthru
1283813	1	Mount Plate Motor
0688529	1	Strain Relief Con L
0688530	1	Strain Relief Con S
0688531	1	Serial Cable
0688532	2	Fiber Optic Cable
0490954	1	Safety Gate Relay
0242237	1	Magnet Sensor
1010154	1	Coded Magnet
1283814	1	Top Plate
1283815	1	Bottom Plate
1283816	2	Spacer Block
1283828	2	Low Profile Lubricator
1020258	2	Lubrication Felt Pad
0688535	5	Fuse
0829009	1	Fuse Kit
0829010	1	Spare Parts Kit
0688541	1	Optional SS Enclosure
0688540	1	Standard Enclosure
1283851	1	Actuator Assembly